

AMR-OP71B/xx

Programmable on-wall controller

Operation manual

Version 1.01



AMiT, spol. s r. o. does not provide any warranty concerning the contents of this publication and reserves the right to change the documentation without obligation to inform anyone or any authority about it.

This document can be copied and redistributed under following conditions:

1. The whole text (all pages) must be copied without any changes.
2. All redistributed copies must retain the AMiT, spol. s r. o. copyright notice and any other notices contained in the documentation.
3. This document must not be distributed for purpose making of profit.

The names of products and companies used herein can be trademarks or registered trademarks of their respective owners.

AMiT is a registered trademark.

**Copyright (c) 2015, AMiT, spol. s r. o.
Producer: AMiT, spol. s r. o.
Naskové 1100/3, 150 00 Praha
www.amitotion.com**

Technical support: support@amit.cz

Contents

	History of revisions	4
	Related documentation.....	4
1.	Introduction	5
2.	Technical parameters	6
2.1.	Dimensions.....	7
2.2.	Recommended drawing symbol	8
3.	Conformity assessment	9
3.1.	Other tests	10
4.	Power supply.....	11
5.	RS485 communication line	13
6.	Mounting	16
6.1.	Casing removal.....	17
6.2.	Battery insertion.....	17
6.3.	Installation rules.....	18
7.	Setup and operation of wall controller	19
7.1.	Basic screen	19
7.2.	User's menu	23
	Menu items.....	24
7.3.	Configuration menu	30
	Menu items.....	31
7.3.1	Communication settings	34
7.4.	Screen saver	39
8.	ARION protocol program operation	40
8.1.	Digital inputs	40
8.2.	Digital outputs.....	41
8.3.	Register layout.....	41
8.4.	Operating time setting	42
9.	MODBUS protocol program operation.....	43
9.1.	Register layout.....	43
9.2.	Operating time setting	45
10.	Programming.....	46
10.1.	Setting of communication parameters	46
10.2.	Service application	46
10.3.	Service menu.....	47
10.4.	Loader	48
11.	Factory settings	49
12.	Ordering information and completion	50
12.1.	Completion	50
13.	Maintenance	51
14.	Waste disposal.....	52

History of revisions

Document name: amr-op71bxx_g_en_101.pdf

Author: Petr Bělík, Zbyněk Říha

Revision	Date	Changes
100	13. 4. 2012	New document
101	26. 5. 2015	Chapters 2., 4., 5., 8.3., 9.1., 10., 11 corrected. Figures corrected.

Related documentation

1. DetStudio Development Environment Help
2. **AMR-OP71B/xx** – Data sheet
file: amr-op71bxx_d_en_xxx.pdf
3. Application Note AP0016 – Principles of using RS485 interface
file: ap0016_en_xx.pdf

1. Introduction

AMR-OP71B/xx is a programmable on-wall controller. It is connected to superior control system via RS485 line. The whole display area consists of touch panel, which serves for on-wall controller operation.

- Basic features**
- Measuring of room temperature
 - FSTN display with (64 × 132) resolution
 - Touchscreen operating
 - RS485 line without galvanic separation
 - Power supply 24 V DC
 - Programming in DetStudio environment / EsiDet
 - MODBUS or ARION communication protocol
 - Software selection of different control methods
 - Variant 1 – Room mode
 - Variant 2 – Room mode + fan mode
 - Variant 3 – Room mode + bistable switch

2. Technical parameters

Processor	Type	STM32F103RE
	FLASH memory	512 KB
	SRAM	64 KB
	EEPROM	2 KB
	RAM + RTC back-up	Lithium battery CR1632
	Battery lifetime	4 years in a normal environment *)

Note *) Normal environment is defined at 25 °C temperature.
Device is supplied without battery.

RTC	Type	STM32F103RE (processor component)
	Precision at 25 °C	±20 ppm

Display	Type	FSTN/positive/BW
	Resolution	(132 × 64) pixels
	Visible area	(58 × 38) mm
	Viewing angle	90 °
	Backlight	LED
	Backlight colour	White
	Backlight lifetime	Min. 50 000 hours *)

Note *) Luminance drop to 50 %.

Touch panel	Type	Resistive
	Number of touches	10 ⁶
	Touching strength	10 g to 100 g
	Hardness	≥ 3 H

Note Touch panel is intended for operating by finger, by tool without sharp edges or by finger-in-glove.

Temperature sensor	Type	DS7505
	Measuring range	-55 °C to +125 °C *)
	Resolution	12 bit
	Accuracy	±2 °C (-55 °C to 0 °C) ±0.5 °C (0 °C to 50 °C) ±2 °C (50 °C to 125 °C)
	Device temperating	45 min **)

Note *) Thermal sensor parameters. Operating temperature range of on-wall controller is lower.

**) Time from power on. Measurement accuracy is reduced to ±2 °C, during this time.

RS485	Overvoltage protection	Transil 600 W
	Galvanic separation	No
	Terminating resistor *)	120 Ω on the unit
	Idle state definition *)	
	to +5 V	820 Ω on the unit
	to 0 V	820 Ω on the unit
	Maximum wire length	1200 m / 19200 bps
Max. number of stations on segment	256	

Connection point	CHF5/2 terminal
Wire cross section	0.75 mm ² to 2.5 mm ²

Note *) Terminating resistor and idle state definition are connected concurrently.

Power supply	Nominal power supply voltage	24 V DC
	Power supply voltage range	10 V DC to 30 V DC
	Maximum power consumption	40 mA at 24 V DC
	Connection point	CHF5/2 terminal
	Wire cross section	0.75 mm ² to 2.5 mm ²

Mechanics	Mechanical design	Plastic cover, ABS
	Mounting	Vertical (on the wall)
	Ingress protection rate	IP20
	Dimensions (w × h × d)	(90 × 110 × 29) mm
	Weight – netto – brutto	0.12 kg ±5 % 0.15 kg ±5 %

Temperatures	Operating temperature range	-10 °C to 50 °C
	Storage temperature range	-20 °C to 70 °C

Others	Maximum ambient humidity	< 95 % non-condensing
	Programming	DetStudio / EsiDet
	Communication protocol	ARION / MODBUS
	Max. number of stations on network	63 ARION / 247 MODBUS

2.1. Dimensions

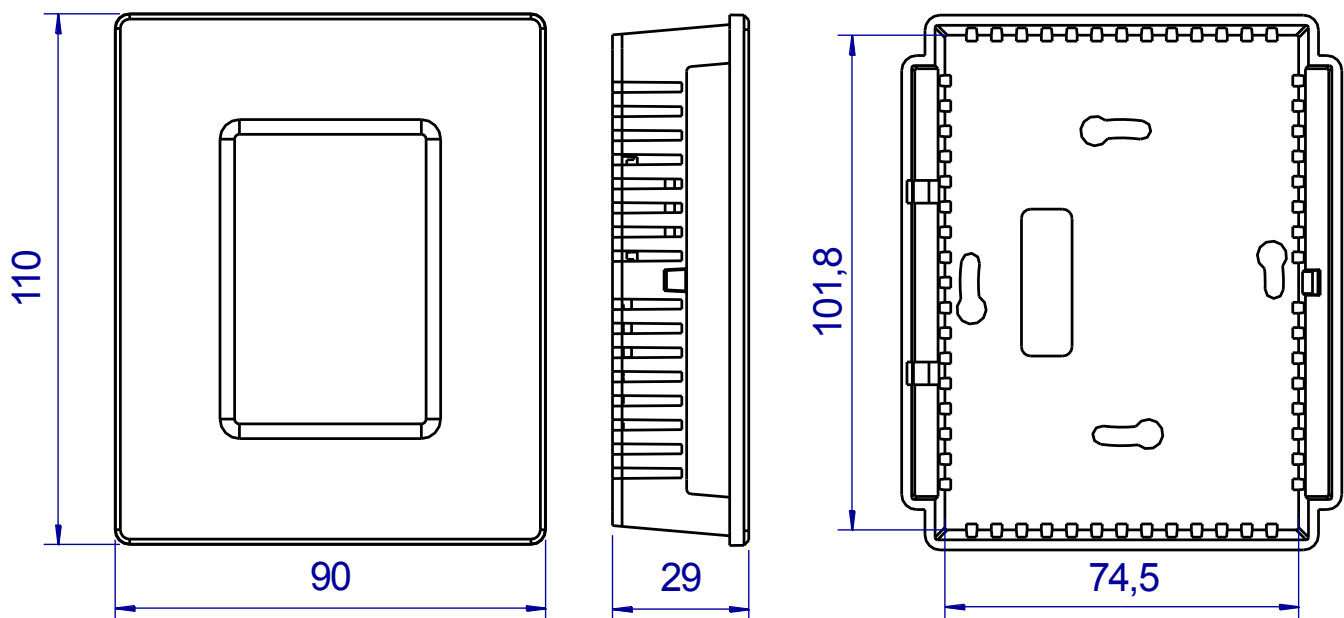

Fig. 1 - **AMR-OP71B/XX** dimensions

2.2. Recommended drawing symbol

Following drawing symbol is recommended for **AMR-OP71B/xx** on-wall controller.

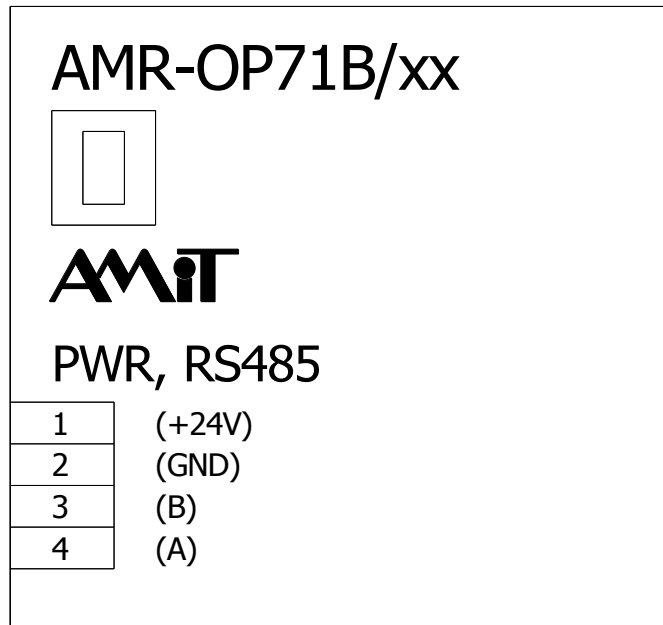

Fig. 2 - Recommended drawing symbol for **AMR-OP71B/xx**

3. Conformity assessment

The equipment meets the requirements of NV616/2006 Czech governmental decree. The compliance assessment with NV616/2006 has been performed in accordance with harmonized standard EN 61326-1.

Tested in accordance with standard	Type of test	Classification
EN 55011:2009	Industrial, scientific and medical equipment – Radio-frequency disturbance characteristics – Limits and methods of measurement	complies
EN 61000-4-2:2009	Electromagnetic compatibility (EMC) – Part 4-2: EMC – Testing and measurement techniques – Electrostatic discharge immunity test, aerial discharge	± 8 kV
EN 61000-4-3:2006	Electromagnetic compatibility (EMC) – Part 4-3: Testing and measurement techniques – Radiated, radio-frequency, electromagnetic field immunity test, 800 MHz to 1000 MHz	20 V/m
EN 61000-4-3:2006	Electromagnetic compatibility (EMC) – Part 4-3: Testing and measurement techniques – Radiated, radio-frequency, electromagnetic field immunity test, 1000 MHz to 2100 MHz	10 V/m
EN 61000-4-3:2006	Electromagnetic compatibility (EMC) – Part 4-3: Testing and measurement techniques – Radiated, radio-frequency, electromagnetic field immunity test, 2100 MHz to 2500 MHz	5 V/m
EN 61000-4-4:2012	Electromagnetic compatibility (EMC) – Part 4-4: Testing and measurement techniques – Electrical fast transient/burst immunity test, power supply	± 2 kV *)
EN 61000-4-4:2012	Electromagnetic compatibility (EMC) – Part 4-4: Testing and measurement techniques – Electrical fast transient/burst immunity test, RS485	± 2 kV *)
EN 61000-4-5:2006	Electromagnetic compatibility (EMC) – Part 4-5: Testing and measurement techniques – Surge immunity test, power supply	± 2 kV *)
EN 61000-4-5:2006	Electromagnetic compatibility (EMC) – Part 4-5: Testing and measurement techniques – Surge immunity test, RS485	± 1 kV *)
EN 61000-4-6:2009	Electromagnetic compatibility (EMC) – Part 4-6: Testing and measurement techniques – Immunity to conducted disturbances, induced by radio-frequency fields	10 V

3.1. Other tests

Device was tested according to:

Tested in accordance with standard	Type of test	Result
EN 60068-2-1:2007	Environmental testing – Part 2-1: Tests – Test A: Cold	Complies
EN 60068-2-2:2007	Environmental testing – Part 2-2: Tests – Test B: Dry heat	Complies
EN 61000-4-29:2000	Electromagnetic compatibility (EMC) – Part 4-29: Testing and measurement techniques – Voltage dips, short interruptions and voltage variations immunity tests	Complies

4. Power supply

AMR-OP71B/xx on-wall controller can be powered by DC power sources, that meet the requirements, listed in chapter 2. Technical parameters.

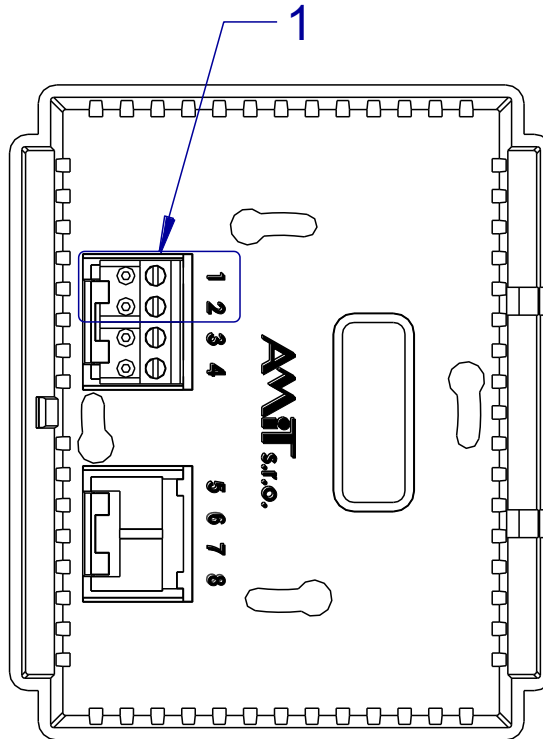

Fig. 3 - Power supply connector location

<i>Legend</i>	Number	Meaning
	1	Power supply connector

<i>Connector wiring</i>	Terminal	Label	Meaning
	1	+24V	Power supply +24 V DC
	2	GND	Power supply Ground

Wiring example

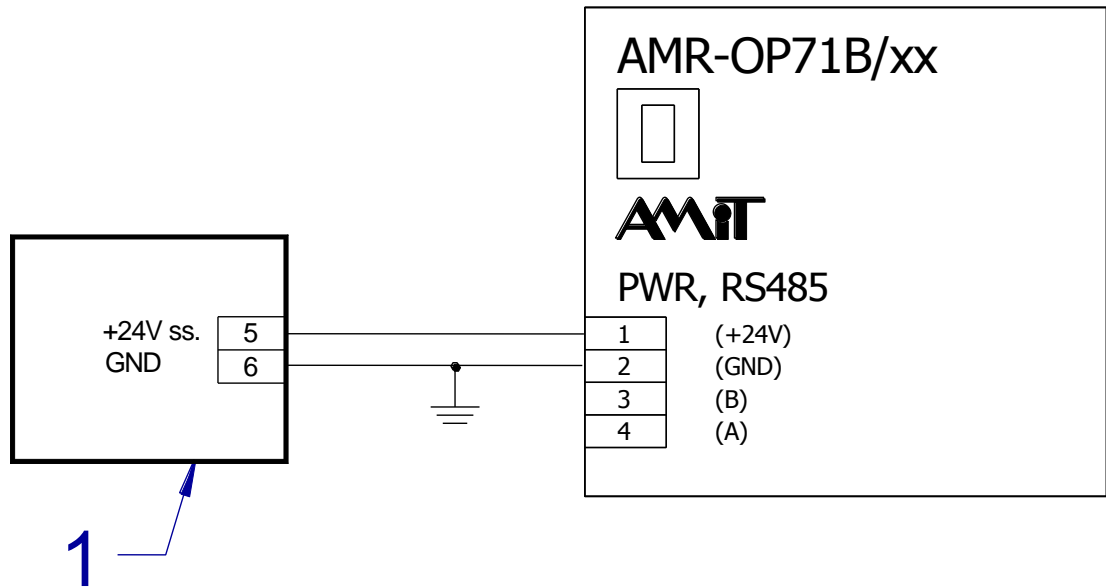

Fig. 4 - Power supply wiring example

Legend

Number	Meaning
1	External power source

Note It is recommended to connect the GND terminal in one point with switchboard PE terminal when installation is made.

5. RS485 communication line

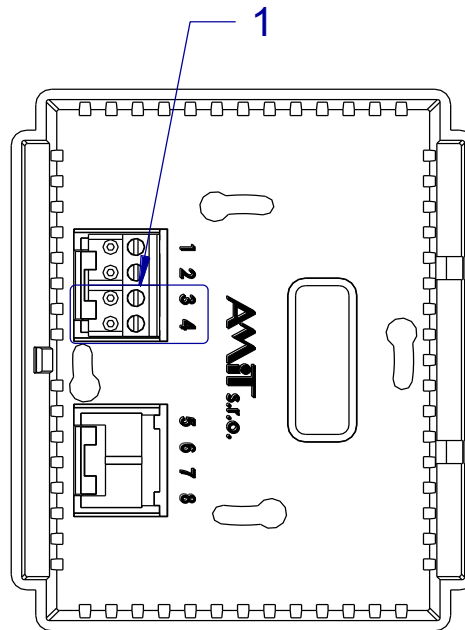

Fig. 5 - RS485 connector location

<i>Legend</i>	Number	Meaning
	1	RS485 connector

Connector wiring	Terminal	Label	Meaning
	3	B	RS485 line, signal B
	4	A	RS485 line, signal A

On-wall controller is connected with superior control system via RS485 communication line. For proper working of RS485 is necessary to abide the rules presented in Application Note AP0016 – Principles of using RS485 interface.

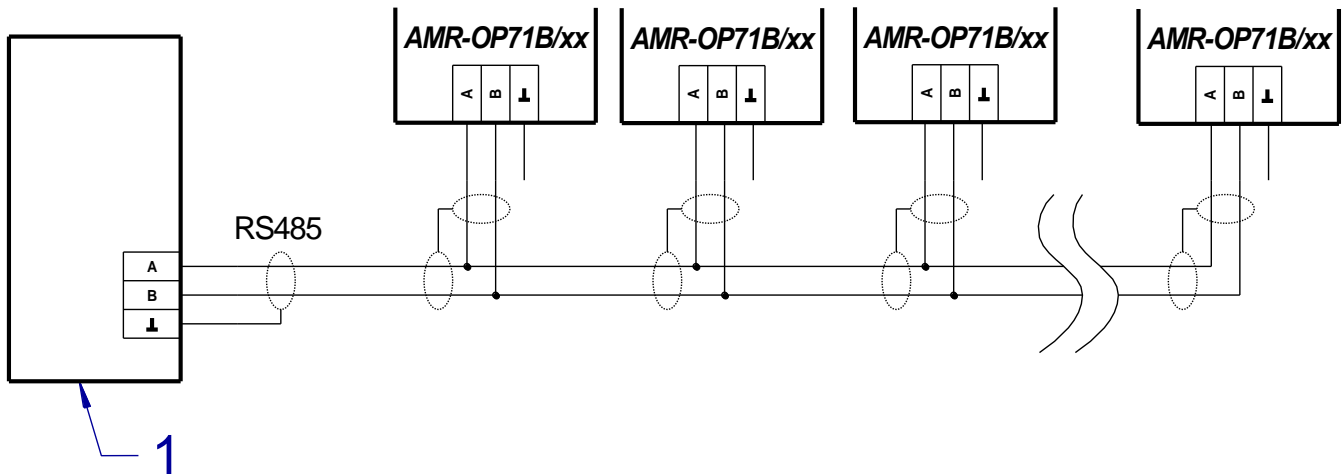

Fig. 6 - RS485 wiring

Legend	Number	Meaning
	1	Superior control system

In case of using structured cabling, it is recommended to connect one pair of wires to the positive terminal, one pair of wires to the negative terminal and one pair of wires to connect RS485 line.

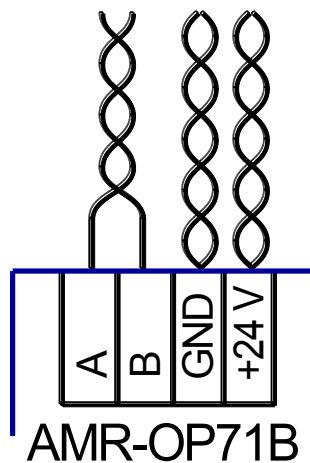

Fig. 7 - Connecting structured cabling to terminals of the controller

RS485 line termination Each station on RS485 communication line must have properly set the line termination resistors. For termination adjusting are used configuration jumpers, located near the RS485 connector. When jumpers are fitted, line termination is connected. The line terminating stations must have the termination always connected, and intermediate stations disconnected.

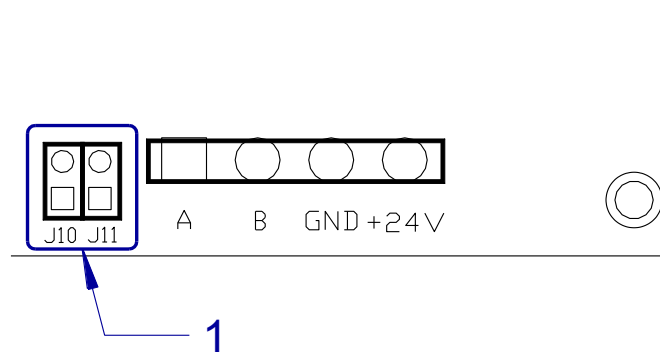

Fig. 8 - RS485 configuration jumpers location

<i>Legend</i>	Number	Meaning
	1	RS485 configuration jumpers

<i>Meaning of jumpers</i>	Jumpers	Meaning
	Are set	End-station – Idle state and line termination is active
	Are not set	Intermediate station – Idle state and line termination is inactive

Note Idle state on RS485 line wires is defined by configuration jumpers installation.

Activity indication Activity on RS485 line is indicated on LCD. If it is not specified other way in control system (via Guard Time), text ERROR is displayed in status line 30 s after communication interruption (see chapter 7.1 Basic screen).

6. Mounting

On-wall controller is intended to be mounted in internal, dry environment. Should be placed in about 1.5 m above the floor, in area with good air circulation. Controller should not be placed in area where it's temperature can be affected by the wind, sunshine, heat radiation from the heater, or other factors. If the inlet wires are led thru the plastic tube- it is necessary to seal the tube to avoid air flow.

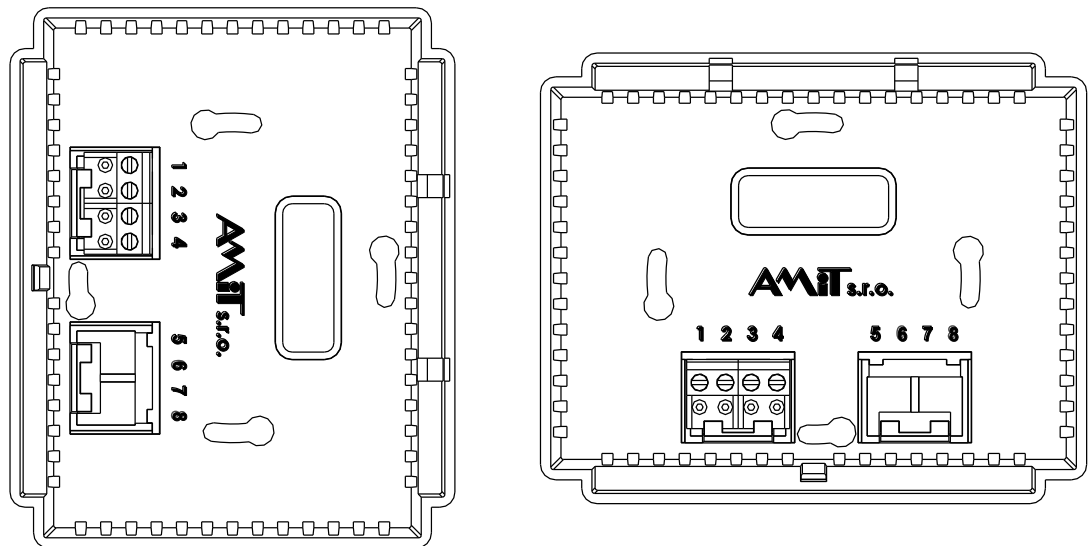

Fig. 9 - On-wall controller mounting in vertical position (left), in horizontal position (right)

Vertical mounting On-wall controller is mounted according to Fig. 9 - left. Temperature sensor is located in left lower corner.

Horizontal mounting On-wall controller is mounted according to Fig. 9 - right. Temperature sensor is located in right lower corner.

Note In case of incorrect mounting, temperature sensor is affected by the heat radiated by the electronics of the controller, that results in incorrect temperature readings.

6.1. Casing removal

1. Release the cover by pressing a latch on the on-wall controller left side (for example, with a screwdriver or a blunt-tip). Then take off on-wall controller front part.

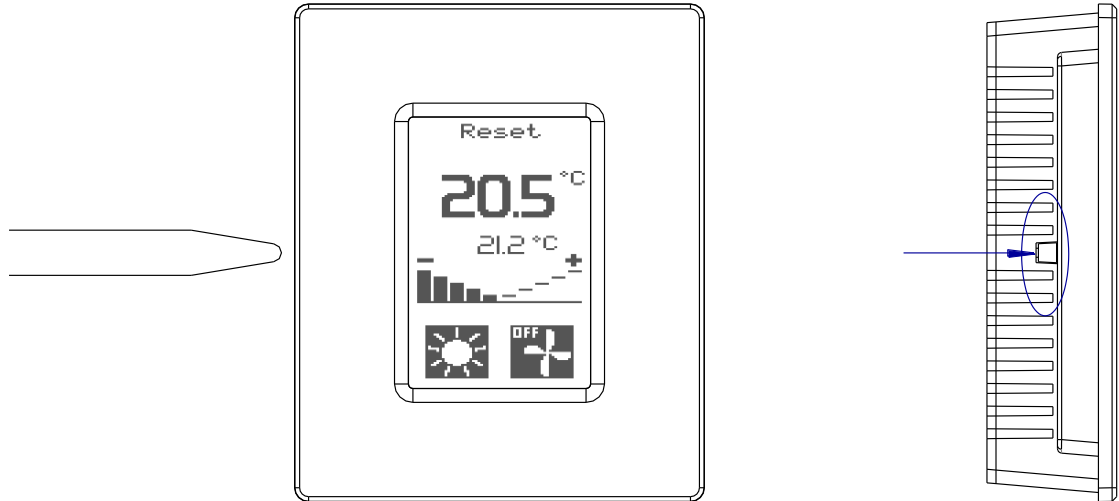

Fig. 10 - Place, that must be pressed with blunt-tip

2. Mount rear cover on a selected location. There are two pairs of mounting holes available.
3. Connect communication and power supply wires (see chapter 4. Power supply and chapter 5. RS485 communication line).
4. Set the configuration jumpers (see chapter 5. RS485 communication line).
5. Put the upper part on a rear cover and press gently until the latch clicks.

6.2. Battery insertion

To insert batteries unmount the on-wall controller front part from the rear cover, and insert batteries in direction of arrow. Battery type: CR1632.

The proper polarity is marked both on battery holder and battery.

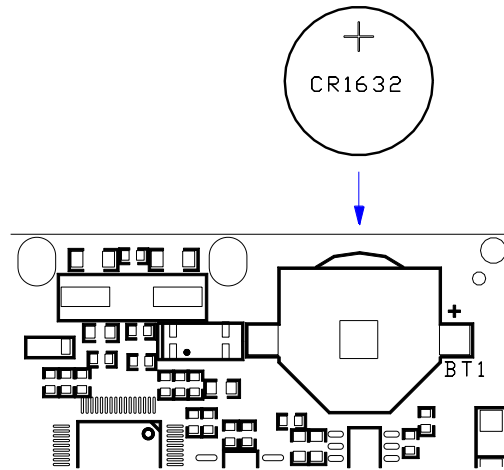

Fig. 11 - Battery insertion

6.3. Installation rules

EMC filter EMC filter is used on power supply input. Based on environment nature, power source properties and wiring layout this requirement can be revised.

Connecting to PE Connect negative supplying terminal of the unit (GND) to the switchboard PE terminal (at the power source).

If the wires are led outside the building, the appropriate inputs and outputs needs to be overvoltage protected.

RS485 line It is necessary to perform connecting of RS485 line according to recommendations presented in Application Note AP0016 – Principles of using RS485 interface.

Note All connections to PE terminal must be realized with impedance as low as possible. Technical parameters of unit are guaranteed only when these wiring rules are applied.

7. Setup and operation of wall controller

On-wall controller has several working screens.

- Basic displayed all time.
- User menu is displayed by press on a particular area of a display.
- Configuration menu Is displayed by pressing continuously on a particular area of a display.
- Screen saver if screen saver is allowed – it will be displayed after pre-set time of controller inactivity.

7.1. Basic screen

Basic screen look depends on application variant. Variant is set by the service organization, during on-wall controller installation. Part of basic screen is common for all versions, part depends on chosen mode.

Common icons

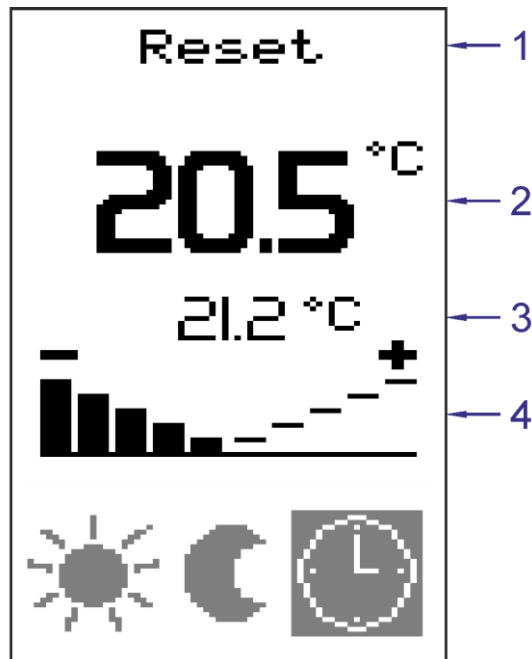

Fig. 12 - Common icons

Legend

Number	Meaning
1	Status bar
2	Measured temperature
3	Requested temperature
4	Correction

Status bar



Fig. 13 - Status bar

Following data are displayed:

Status	Meaning
Reset	Controller restarted. No communication took place since the restart.
Error	Communication error. Time longer than Guard Time elapsed since last communication.
Menu	Flawless operation of the unit.

Measured temperature



Fig. 14 - Measured temperature

Room temperature is displayed on LCD independently of communication.

Requested temperature.



Fig. 15 - Requested temperature

Temperature is sent by the superior control system. During correction change hyphens are displayed, until new requested value is received from the superior control system. Value could be shown with several second delays.

Correction bar graph



Fig. 16 - Correction of required temperature

Bargraph is displayed only in Auto mode. It is not displayed in other modes (Energy saving and Comfort)

Correction value is changed to plus or minus by pressing left or right side of the bargraph. After each correction change, instead of requested temperature, hyphens are displayed, until new requested temperature value is received from the superior control system.

Mode icons Mode icons depend on application.

Variant 1

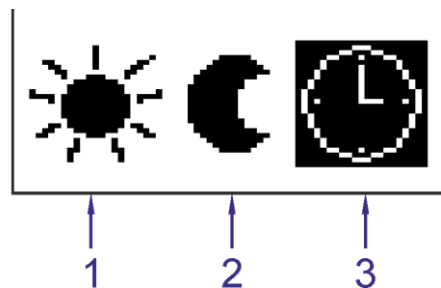

Fig. 17 - Icon for mode variant 1

Legend

Number	Meaning
1	Comfort mode
2	Energy saving mode
3	Mode Auto

Three icons are displayed for room mode. Highlighted Icon indicates selected room mode. Mode is activated by pressing on a particular icon.

Icon	Meaning	Description
	Comfort	Is regulated to constant (comfort) temperature.
	Energy saving	Is regulated to constant (power saving) temperature.
	Auto	Is regulated according to time plan, adjusted by correction value.

Variant 2

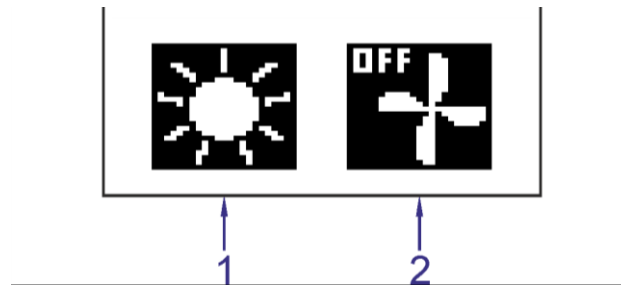

Fig. 18 - Icon for mode variant 2

Legend

Number	Meaning
1	Room mode
2	Fan mode

Icon for ventilation and room mode is displayed. By pressing the room mode icon you can switch between three states.

Icon	Meaning	Description
	Comfort	Is regulated to constant (comfort) temperature.
	Energy saving	Is regulated to constant (power saving) temperature.
	Auto	Is regulated according to time plan, adjusted by correction value.

By pressing the ventilation icon you can switch between five states.

Icon	Meaning	Description
	OFF	Fan is off.
	Auto	Fan is controlled automatically.
	Speed 1	Fan speed is set to level 1.
	Speed 2	Fan speed is set to level 2.
	Speed 3	Fan speed is set to level 3.

Variant 3

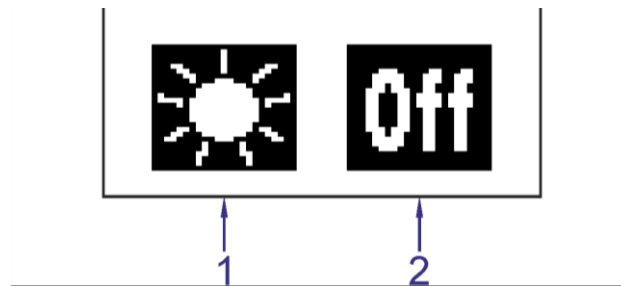





Fig. 19 - Icon for mode variant 3



Legend

Number	Meaning
1	Room mode
2	Switch

Room mode icon and power off icon are displayed. By pressing the room mode icon you can switch between three states.

Icon	Meaning	Description
	Comfort	Is regulated to constant (comfort) temperature.
	Energy saving	Is regulated to constant (power saving) temperature.
	Auto	Is regulated according to time plan, adjusted by correction value.

By pressing the power off icon you can switch between two states.

Icon	Meaning	Description
	Off	Switch is off.
	On	Switch is on.

7.2. User's menu

User menu is called out by pressing the area shown below.

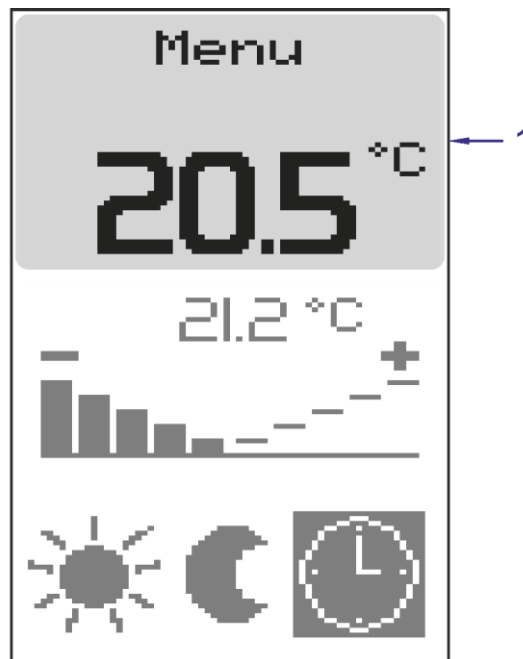

Fig. 20 - Calling user menu

Legend

Number	Meaning
1	Area for pressing

Menu items

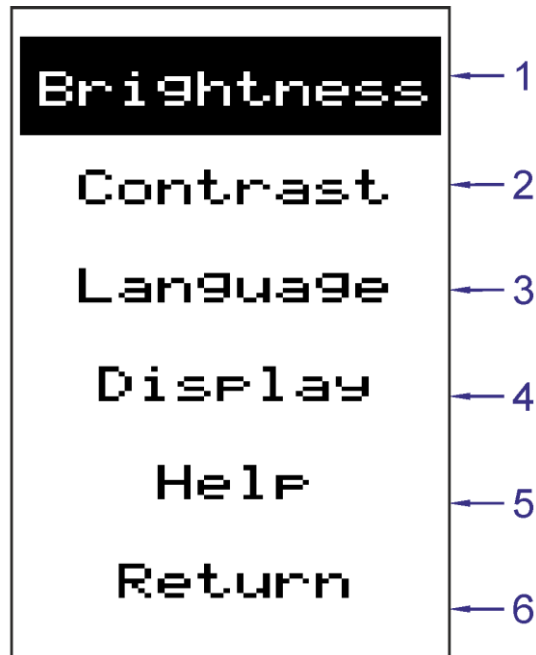

Fig. 21 - User menu items

Legend

Number	Meaning
1	Brightness adjustment
2	Contrast setting
3	Language selection
4	Screen saver setting
5	Firmware version
6	Return back

Brightness The display brightness can be set, by item **Brightness**.

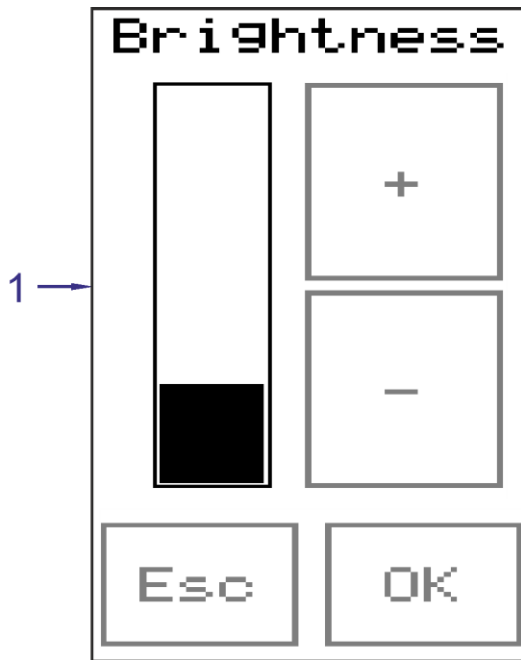

Fig. 22 - Brightness adjustment

Legend

Number	Meaning
1	Set level of brightness

Contrast The display contrast can be set, by item **Contrast**.

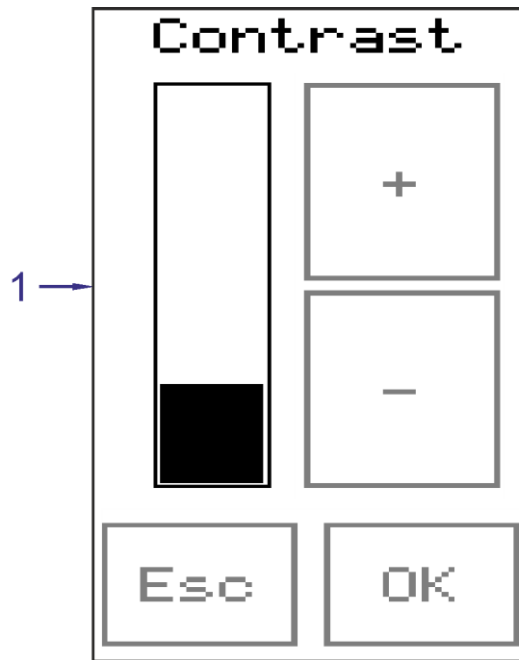

Fig. 23 - Contrast setting

Legend

Number	Meaning
1	Set level of contrast

Language Item **Language** allows to switch between Czech and English texts on on-wall controller.



Fig. 24 - Language selection

Legend

Number	Meaning
1	Language selection

Display Item **Display** allows to set screen saver time delay.



Fig. 25 - Setting time for screen saver activation

Legend

Number	Meaning
1	Time set for screen saver activation

Following values can be set:

Value	Meaning
-1	Screensaver is off.
10 to 120	Screen saver time delay in seconds.

Help By selecting item **Help**, the actual version of application software, loaded in to the controller, is displayed.



Fig. 26 - Firmware version

Legend

Number	Meaning
1	Return back

Return By pressing icon **Back** you can return to the basic screen of on-wall controller.

7.3. Configuration menu

Configuration menu can be called-out by a long press on area shown below for at least 10 s.

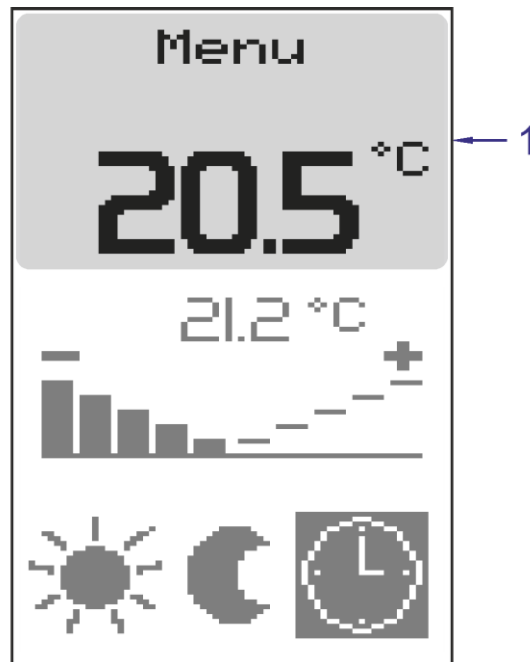

Fig. 27 - Calling configuration menu

<i>Legend</i>	Number	Meaning
	1	Area for pressing

Caution Setting of on-wall controller (software and hardware) should be performed strictly by service company. Wrong configuration settings could result in a controller malfunction.

Menu items

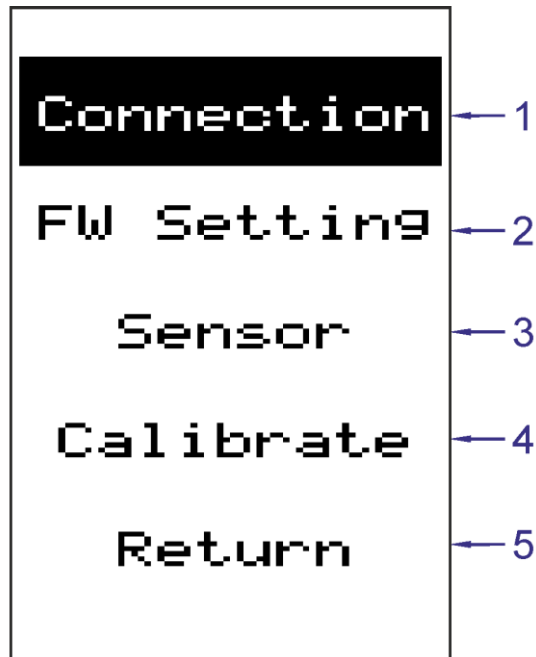

Fig. 28 - Configuration menu items

Legend

Number	Meaning
1	Communication settings
2	Variant selection
3	Correction of temperature sensor
4	Calibration
5	Return back

Connection AMR-OP71B/xx communication parameters can be set via **Connection** item. Closer information can be found in chapter 7.3.1 Communication settings.

Variant Via item **Variant**, the one of three variants of **AMR-OP71B/xx** can be selected (see chapter 7.1. Basic screen).

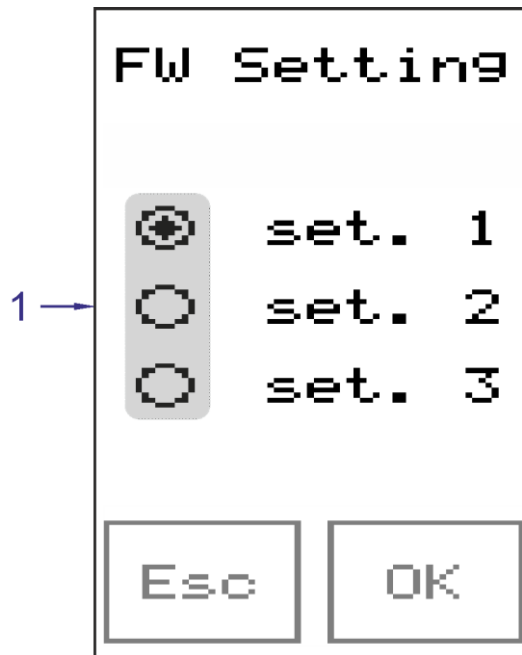

Fig. 29 - Variant selection

Legend

Number	Meaning
1	Variant selection

Sensor Correction of the sensor, located inside the controller, can be performed via item **Sensor**.

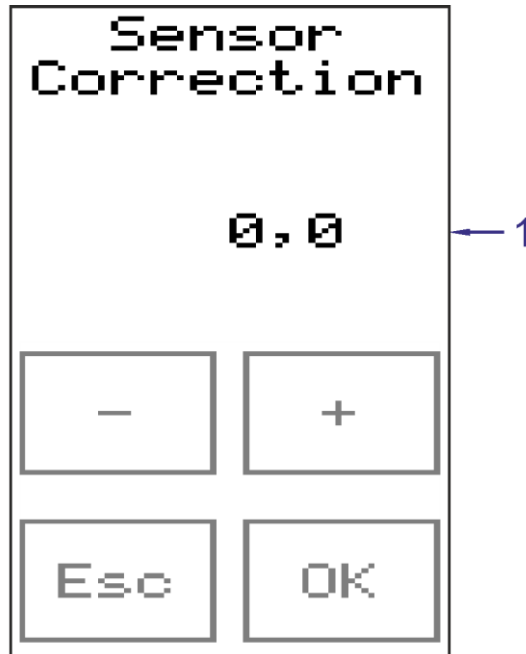

Fig. 30 - Correction of temperature sensor

Legend

Number	Meaning
1	Set correction value

Calibration Touch screen can be calibrated via **Calibration** item.

Return Pressing the **Return** item will restart on-wall controller (this will confirm the settings) and will return controller to it's initial screen.

7.3.1 Communication settings

Communication type and parameters can be set in configuration menu via item **Connection**

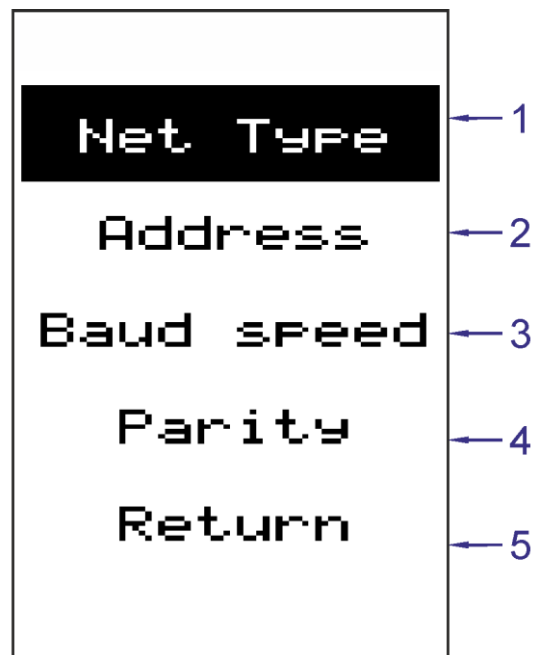

Fig. 31 - Menu with communication settings

Legend

Number	Meaning
1	Protocol selection
2	Address setting
3	Setting speed
4	Setting parity (only for MODBUS protocol)
5	Return back

Network type Under item **Network type**, one of two communication protocols can be selected:

- ARION,
- MODBUS.



Fig. 32 - Communication protocol selection

<i>Legend</i>	Number	Meaning
	1	Protocol selection

- Address** Under the **Address** item, the address within selected communication network can be set. Each unit must have unique address. Allowed address range is:
- 1 to 63 (ARION),
 - 1 to 247 (MODBUS).



Fig. 33 - Address setting

<i>Legend</i>	Number	Meaning
	1	Adjusted address

Speed Under the item **Speed**, the communication speed within selected communication network can be set. All connected to the network devices must have same connection speed (according to communication speed of the superior control system).

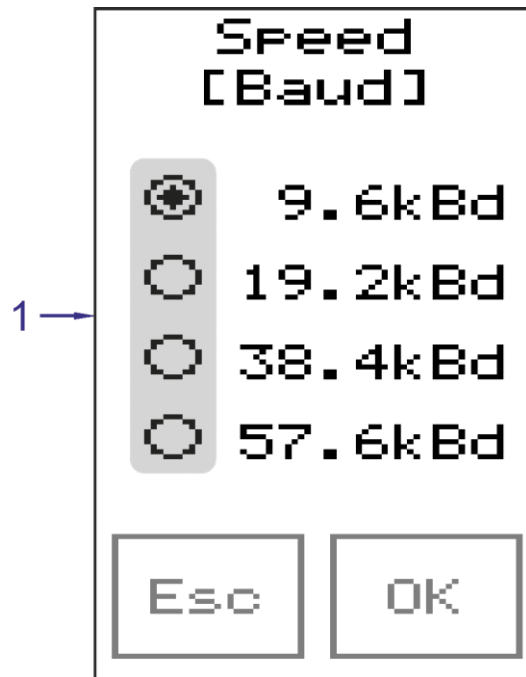

Fig. 34 - Setting communication speed

Legend

Number	Meaning
1	Selection of speed

Parity There is a point to set this item only if the MODBUS protocol was selected. Parity can be set by this item.

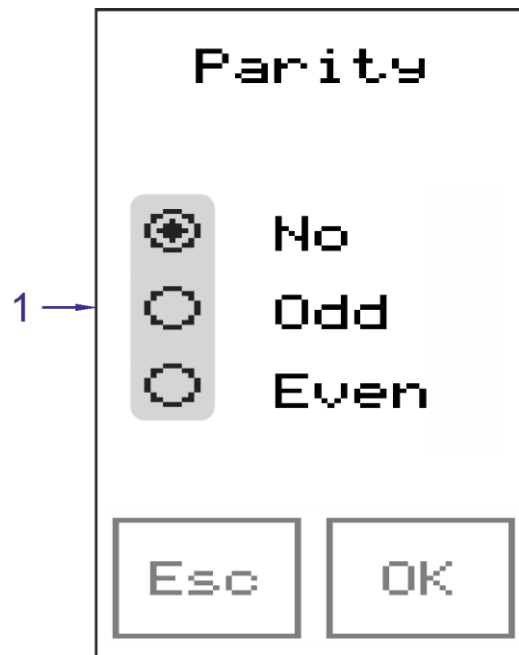

Fig. 35 - Setting parity for MODBUS protocol

Legend

Number	Meaning
1	Selection of parity

Return To return to configuration menu – select item **Return**.

7.4. Screen saver

If allowed in menu, screen saver is displayed after preset time (screen saver is displayed, backlight is off) After first touch of the screen – backlight is turned on, after second touch – basic screen is displayed.

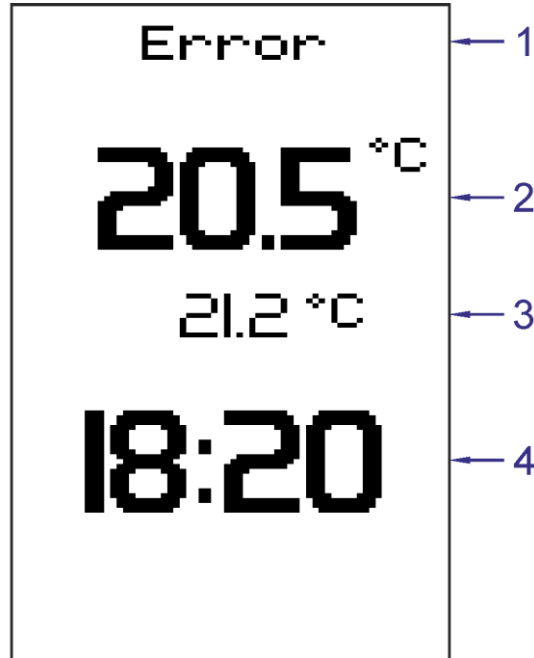

Fig. 36 - Screen for screen saver

Number	Meaning
1	Status bar
2	Measured temperature
3	Requested temperature
4	Time of superior system

When screen saver is active, status bar display only Reset and Error status (see chapter Status bar).

Note If time is not transmitted over the network, -- is displayed instead of numerical value.

8. ARION protocol program operation

In ARION network **AMR-OP71B/xx** can acquire following states:

- Reset** Bits 0 to 7 of the **Status** registry are set to value True after the restart of on-wall controller. On-wall controller does not have a valid value:
- room and fan mode setting
 - button status,
 - correction values (it has a zero value),
 - required temperature.

The correct value can be written only by a superior control system. Values that have been written by the user will be ignored, until the valid value from the superior control system is received.

- Error** On-wall controller supports communication interruption control (parameter **Guard Time** in ARION network). In case the communication is broken – the text **Error** will be displayed in a status bar, and the controller will have the same behaviour like in **Reset** state (with exception of correction value, which remains at initial value). If the superior control system does not use **Guard Time** parameter, and on-wall controller is not receiving valid frame within 30 s, it automatically switches to **Error** state.

8.1. Digital inputs

On-wall controller status information is transmitted in digital inputs.

<i>Description of the function module</i>	Function module	Number of signals	Note
	ARI_DigIn	3	Via module, more signals can be read simultaneously. Single signals correspond with single bits of database variables.

<i>Meaning of single signals</i>	Module signal	Meaning
	0	Restart.
	1	Writing to arbitrary register from the side of the controller has occurred.
	2	Communication interruption.

- Note* We recommend periodic reading of digital input channel. If recording to registry from the side of on-wall controller has occurred, bit n.1 of this channel (DI.1) is set to value True. Once the superior control system reads-out the value from the registry, it sets bit n.1 of digital input channel to value False by writing value True to bit n.1 of digital output channel (DO.1).

8.2. Digital outputs

Single bits of digital input channels are set to value False by corresponding digital outputs.

<i>Description of the function module</i>	Function module	Number of signals	Note
	ARI_DigOut	3	More signals simultaneously can be written by the module. Single signals correspond with single bits of the database variable.

<i>Meaning of single signals</i>	Module signal	Meaning
	0	Zeroing bit DI.0
	1	Zeroing bit DI.1
	2	Zeroing bit DI.2

8.3. Register layout

Register with number 0

Name	Number	Type	Description
Status reset	0 (Bit 0 to 15)	R/W	Zeroing corresponding bits of Status registry. The bit is set in case of simultaneous writing of value True to the setting and zeroing bit (prevailing "set"). While reading this registry, the last recorded value is returned.
Status set	0 (Bit 16 to 32)	R/W	Setting corresponding bits of Status registry. The bit is set in case of simultaneous writing of value True to the setting and zeroing register (prevailing "set"). While reading this registry, the last recorded value is returned.

Registers with numbers 1 to 6

Name	Number	Type	Description																							
Status	1	R	Meaning of single bits <table border="1" style="width: 100%; border-collapse: collapse;"> <thead> <tr> <th>Bit</th> <th>Meaning</th> </tr> </thead> <tbody> <tr> <td>0</td> <td>Change of value from the controller. This bit is set when the value of Status registry is changed by the on-wall controller. Value of this bit has no effect on the controller function.</td> </tr> <tr> <td>1 2</td> <td>Room mode. <table border="1" style="width: 100%; border-collapse: collapse;"> <thead> <tr> <th>Bit 2</th> <th>Bit 1</th> <th>Meaning</th> </tr> </thead> <tbody> <tr> <td>0</td> <td>0</td> <td>Automat</td> </tr> <tr> <td>0</td> <td>1</td> <td>Energy saving</td> </tr> <tr> <td>1</td> <td>0</td> <td>Comfort</td> </tr> <tr> <td>1</td> <td>1</td> <td>Not used</td> </tr> </tbody> </table> </td> </tr> <tr> <td>3</td> <td>Switch. Applies only for the Variant 3. In other variants this bit is not used.</td> </tr> </tbody> </table>	Bit	Meaning	0	Change of value from the controller. This bit is set when the value of Status registry is changed by the on-wall controller. Value of this bit has no effect on the controller function.	1 2	Room mode. <table border="1" style="width: 100%; border-collapse: collapse;"> <thead> <tr> <th>Bit 2</th> <th>Bit 1</th> <th>Meaning</th> </tr> </thead> <tbody> <tr> <td>0</td> <td>0</td> <td>Automat</td> </tr> <tr> <td>0</td> <td>1</td> <td>Energy saving</td> </tr> <tr> <td>1</td> <td>0</td> <td>Comfort</td> </tr> <tr> <td>1</td> <td>1</td> <td>Not used</td> </tr> </tbody> </table>	Bit 2	Bit 1	Meaning	0	0	Automat	0	1	Energy saving	1	0	Comfort	1	1	Not used	3	Switch. Applies only for the Variant 3. In other variants this bit is not used.
Bit	Meaning																									
0	Change of value from the controller. This bit is set when the value of Status registry is changed by the on-wall controller. Value of this bit has no effect on the controller function.																									
1 2	Room mode. <table border="1" style="width: 100%; border-collapse: collapse;"> <thead> <tr> <th>Bit 2</th> <th>Bit 1</th> <th>Meaning</th> </tr> </thead> <tbody> <tr> <td>0</td> <td>0</td> <td>Automat</td> </tr> <tr> <td>0</td> <td>1</td> <td>Energy saving</td> </tr> <tr> <td>1</td> <td>0</td> <td>Comfort</td> </tr> <tr> <td>1</td> <td>1</td> <td>Not used</td> </tr> </tbody> </table>	Bit 2	Bit 1	Meaning	0	0	Automat	0	1	Energy saving	1	0	Comfort	1	1	Not used										
Bit 2	Bit 1	Meaning																								
0	0	Automat																								
0	1	Energy saving																								
1	0	Comfort																								
1	1	Not used																								
3	Switch. Applies only for the Variant 3. In other variants this bit is not used.																									

Name	Number	Type	Description																																												
			<table border="1"> <tr> <td>4</td> <td colspan="3">Fan mode.</td> </tr> <tr> <td>5</td> <td>Bit 6</td> <td>Bit 5</td> <td>Bit 4</td> <td>Meaning</td> </tr> <tr> <td>6</td> <td>0</td> <td>0</td> <td>0</td> <td>Device is OFF</td> </tr> <tr> <td></td> <td>0</td> <td>0</td> <td>1</td> <td>Level 1</td> </tr> <tr> <td></td> <td>0</td> <td>1</td> <td>0</td> <td>Level 2</td> </tr> <tr> <td></td> <td>0</td> <td>1</td> <td>1</td> <td>Level 3</td> </tr> <tr> <td></td> <td>1</td> <td>0</td> <td>0</td> <td>Automat</td> </tr> <tr> <td colspan="5">Applies only for the Variant 2. In other variants this bits are not used.</td> </tr> <tr> <td>7 *)</td> <td colspan="3">Status of DI input Ni1000 / contact.</td> <td></td> </tr> </table>	4	Fan mode.			5	Bit 6	Bit 5	Bit 4	Meaning	6	0	0	0	Device is OFF		0	0	1	Level 1		0	1	0	Level 2		0	1	1	Level 3		1	0	0	Automat	Applies only for the Variant 2. In other variants this bits are not used.					7 *)	Status of DI input Ni1000 / contact.			
4	Fan mode.																																														
5	Bit 6	Bit 5	Bit 4	Meaning																																											
6	0	0	0	Device is OFF																																											
	0	0	1	Level 1																																											
	0	1	0	Level 2																																											
	0	1	1	Level 3																																											
	1	0	0	Automat																																											
Applies only for the Variant 2. In other variants this bits are not used.																																															
7 *)	Status of DI input Ni1000 / contact.																																														
Correction (Float)	2	R/W	Correction [%]. Range: -100 to 100 with floating point.																																												
Requested temperature (Float)	3	R/W	Requested temperature [°C] with floating point.																																												
Measured temperature (Float)	4	R	Measured temperature [°C] with floating point.																																												
Measured Ni1000 (Float)	5	R	Measured temperature Ni1000 [°C] with floating point.																																												
LED *) brightness (Float)	6	R/W	LED brightness [%]. Range: 0 to 100. Value 0 corresponds with minimal brightness, but not LED power off.																																												

Note *) Is not active in **AMR-OP71B/xx**. Possible writing value to the registry is ignored and does not affect the function of the on-wall controller.

8.4. Operating time setting

On-wall controller allows to display time while screen saver is active (see chapter 7.4 Screen saver). This is a superior control system time, which is displayed only if during ARION network parameterization in the superior control system, the parameter TimeBroadcast is set to value True.

9. MODBUS protocol program operation

In MODBUS network **AMR-OP71B/xx** can acquire following states:

- Reset** Bits 0 to 7 of the **Status** registry are set to value True after the restart of on-wall controller. On-wall controller does not have a valid value:
- room and fan mode setting
 - button status
 - correction values (it has a zero value)
 - required temperature

The correct value can be written only by a superior control system. Values that have been written by the user will be ignored, until the valid value from the superior control system is received.

- Error** On-wall controller supports communication interruption control (**Guar Time** register). In case the communication is broken – the text **Error** will be displayed in a status bar, and the controller will have the same behaviour like in **Reset** state (with exception of correction value, which remains at initial value). If the superior control system does not use **Guard Time** parameter, and on-wall controller is not receiving valid frame within 30 s, it automatically switches to **Error** status.

- Note* Communication with **one stop bit takes place, if there is an odd or even parity set**. Communication with **two stop bits takes place, when no parity is set**.

9.1. Register layout

Supported functions:

- 03 Read Holding Registers – reading register
- 16 Write Multiple Registers – writing registers

All values are saved in BigEndian format.

System registers with addresses 0 to 8 This part is system-managed, and can not be affected by user.

Name	Address	Type	Description
Module ID	0	R	Module identification Unit type is given by number. 35 = AMR-OP7x, is given by HW type.
FW	1	R	Firmware version, is taken from the project.
Time	2 3	R/W	System time. Number of seconds since 1.1.1980, 0:00:00.
Guard Time	4	R/W EEPROM	Number of [ms] for evaluation of MODBUS communication interruption. Zero value will result in permanent disconnection, and Error state.
Baud Rate	5	R/W EEPROM	EEPROM, communication rate.
Parity	6	R/W EEPROM	EEPROM, parity.

Name	Address	Type	Description
Address	7	R/W EEPROM	EEPROM, address.
System Status	8	R/W	System status register. System uses it, it can not be accessed by the application.

Application registers with addresses 100 to 109 This parameters are given by the application program. They can be either pre-defined and system-supported by special object, or it can be programmed by standard objects.

Name	Address	Type	Description																																																			
Status Set	100	R/W	Setting corresponding bits of Status registry. The bit is set in case of simultaneous writing of value True to the setting and zeroing bit (prevailing "set"). While reading this registry, the last recorded value is returned.																																																			
Status Reset	101	R/W	Zeroing corresponding bits of Status registry. The bit is set in case of simultaneous writing of value True to the setting and zeroing register (prevailing "set"). While reading this registry, the last recorded value is returned.																																																			
Status	102 103	R	<p>Meaning of single bits</p> <table border="1"> <thead> <tr> <th>Bit</th> <th>Meaning</th> </tr> </thead> <tbody> <tr> <td>0</td> <td>Change of value from the controller. When the Status register is changed by the on-wall controller, this bit is set. Value of this bit has no affect on the controller function.</td> </tr> <tr> <td>1 2</td> <td>Room mode. <table border="1"> <thead> <tr> <th>Bit 2</th> <th>Bit 1</th> <th>Meaning</th> </tr> </thead> <tbody> <tr> <td>0</td> <td>0</td> <td>Automat</td> </tr> <tr> <td>0</td> <td>1</td> <td>Energy saving</td> </tr> <tr> <td>1</td> <td>0</td> <td>Comfort</td> </tr> <tr> <td>1</td> <td>1</td> <td>Not used</td> </tr> </tbody> </table> </td> </tr> <tr> <td>3</td> <td>Switch. Applies only for the Variant 3. In other variants this bit is not used.</td> </tr> <tr> <td>4 5 6</td> <td>Fan mode. <table border="1"> <thead> <tr> <th>Bit 6</th> <th>Bit 5</th> <th>Bit 4</th> <th>Meaning</th> </tr> </thead> <tbody> <tr> <td>0</td> <td>0</td> <td>0</td> <td>Device is OFF</td> </tr> <tr> <td>0</td> <td>0</td> <td>1</td> <td>Level 1</td> </tr> <tr> <td>0</td> <td>1</td> <td>0</td> <td>Level 2</td> </tr> <tr> <td>0</td> <td>1</td> <td>1</td> <td>Level 3</td> </tr> <tr> <td>1</td> <td>0</td> <td>0</td> <td>Automat</td> </tr> </tbody> </table> <p>Applies only for the Variant 2. In other variants this bits are not used.</p> </td> </tr> <tr> <td>7 *)</td> <td>Status of DI input Ni1000/ contact.</td> </tr> </tbody> </table>	Bit	Meaning	0	Change of value from the controller. When the Status register is changed by the on-wall controller, this bit is set. Value of this bit has no affect on the controller function.	1 2	Room mode. <table border="1"> <thead> <tr> <th>Bit 2</th> <th>Bit 1</th> <th>Meaning</th> </tr> </thead> <tbody> <tr> <td>0</td> <td>0</td> <td>Automat</td> </tr> <tr> <td>0</td> <td>1</td> <td>Energy saving</td> </tr> <tr> <td>1</td> <td>0</td> <td>Comfort</td> </tr> <tr> <td>1</td> <td>1</td> <td>Not used</td> </tr> </tbody> </table>	Bit 2	Bit 1	Meaning	0	0	Automat	0	1	Energy saving	1	0	Comfort	1	1	Not used	3	Switch. Applies only for the Variant 3. In other variants this bit is not used.	4 5 6	Fan mode. <table border="1"> <thead> <tr> <th>Bit 6</th> <th>Bit 5</th> <th>Bit 4</th> <th>Meaning</th> </tr> </thead> <tbody> <tr> <td>0</td> <td>0</td> <td>0</td> <td>Device is OFF</td> </tr> <tr> <td>0</td> <td>0</td> <td>1</td> <td>Level 1</td> </tr> <tr> <td>0</td> <td>1</td> <td>0</td> <td>Level 2</td> </tr> <tr> <td>0</td> <td>1</td> <td>1</td> <td>Level 3</td> </tr> <tr> <td>1</td> <td>0</td> <td>0</td> <td>Automat</td> </tr> </tbody> </table> <p>Applies only for the Variant 2. In other variants this bits are not used.</p>	Bit 6	Bit 5	Bit 4	Meaning	0	0	0	Device is OFF	0	0	1	Level 1	0	1	0	Level 2	0	1	1	Level 3	1	0	0	Automat	7 *)	Status of DI input Ni1000/ contact.
Bit	Meaning																																																					
0	Change of value from the controller. When the Status register is changed by the on-wall controller, this bit is set. Value of this bit has no affect on the controller function.																																																					
1 2	Room mode. <table border="1"> <thead> <tr> <th>Bit 2</th> <th>Bit 1</th> <th>Meaning</th> </tr> </thead> <tbody> <tr> <td>0</td> <td>0</td> <td>Automat</td> </tr> <tr> <td>0</td> <td>1</td> <td>Energy saving</td> </tr> <tr> <td>1</td> <td>0</td> <td>Comfort</td> </tr> <tr> <td>1</td> <td>1</td> <td>Not used</td> </tr> </tbody> </table>	Bit 2	Bit 1	Meaning	0	0	Automat	0	1	Energy saving	1	0	Comfort	1	1	Not used																																						
Bit 2	Bit 1	Meaning																																																				
0	0	Automat																																																				
0	1	Energy saving																																																				
1	0	Comfort																																																				
1	1	Not used																																																				
3	Switch. Applies only for the Variant 3. In other variants this bit is not used.																																																					
4 5 6	Fan mode. <table border="1"> <thead> <tr> <th>Bit 6</th> <th>Bit 5</th> <th>Bit 4</th> <th>Meaning</th> </tr> </thead> <tbody> <tr> <td>0</td> <td>0</td> <td>0</td> <td>Device is OFF</td> </tr> <tr> <td>0</td> <td>0</td> <td>1</td> <td>Level 1</td> </tr> <tr> <td>0</td> <td>1</td> <td>0</td> <td>Level 2</td> </tr> <tr> <td>0</td> <td>1</td> <td>1</td> <td>Level 3</td> </tr> <tr> <td>1</td> <td>0</td> <td>0</td> <td>Automat</td> </tr> </tbody> </table> <p>Applies only for the Variant 2. In other variants this bits are not used.</p>	Bit 6	Bit 5	Bit 4	Meaning	0	0	0	Device is OFF	0	0	1	Level 1	0	1	0	Level 2	0	1	1	Level 3	1	0	0	Automat																													
Bit 6	Bit 5	Bit 4	Meaning																																																			
0	0	0	Device is OFF																																																			
0	0	1	Level 1																																																			
0	1	0	Level 2																																																			
0	1	1	Level 3																																																			
1	0	0	Automat																																																			
7 *)	Status of DI input Ni1000/ contact.																																																					
Correction (Float)	104 105	R/W	Correction [%]. Range: -100 to 100 with floating point.																																																			

Name	Address	Type	Description
Requested temperature (Float)	106	R/W	Requested temperature [°C] with floating point.
	107		
Measured temperature (Float)	108	R	Measured temperature [°C] with floating point.
	109		

Application registers with addresses 110 to 113

Name	Address	Type	Description
Measured Ni1000 *) (Float)	110	R	Measured temperature Ni1000 [°C] with floating point.
	111		
LED *) brightness (Float)	112	R/W	LED brightness [%]. Range: 0 to 100. Value 0 corresponds with minimal brightness, but not LED power off.
	113		

Note *) Is not active in **AMR-OP71B/xx**. Possible writing value to the registry is ignored and does not affect the function of the on-wall controller.

9.2. Operating time setting

Writing time to the single on-wall controller, connected to the MODBUS network is performed by writing to the registers 2 and 3 of the particular on-wall controller.

10. Programming

AMR-OP71B/xx on-wall controller has a user application, installed during production, that provides possibility of universal control of other AMREG type regulators. On-wall controller can be also reprogrammed with own application.

New application can be created by using:

- DetStudio / EsiDet development environment.

Loading of the application to the on-wall controller from the DetStudio can be performed via:

- DetStudio / EsiDet development environment,
- AMRconfig service and programming utility,
- AMRmultidownload multiprogramming utility.

SW Download Development tool can be downloaded from www.amitautomation.com from section Download.

10.1. Setting of communication parameters

Change of communication parameter can be performed:

- from PC via DetStudio / AMRconfig,
- from user application through configuration menu, see chapter 7.3.,
- from service application, via service menu, see chapter 10.3.

Connection to the PC On-wall controller **AMR-OP71B/xx** must be connected to the PC via RS485 converter (for example type **SB485s** from AMIT company production) using point-to-point connection.

Note Communication with station can be established from DetStudio only via MODBUS communication protocol (for example, every time after the loader activation, see chapter 10.4. Loader).

10.2. Service application

Service application supports setting of basic parameters of the on-wall controller via “Service menu”.

Service application in **AMR-OP71B/xx** is always available, user can always switch to it, and it can not be deleted. After switching to service application, the service menu is displayed. Switching procedure is described in following chapters.

10.3. Service menu

Service menu can be activated by:

- disconnecting **AMR-OP71B/xx** from power supply,
- Touching and holding the screen in any place,
- connecting **AMR-OP71B/xx** to power supply,
- releasing the touchscreen.

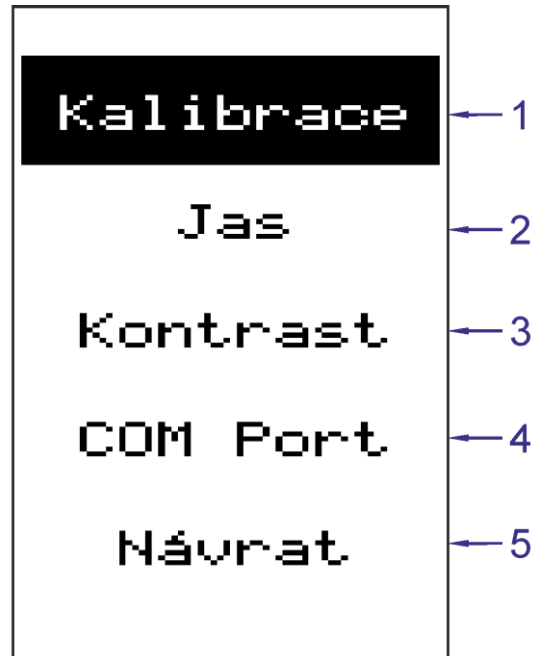

Fig. 37 - Items of service menu

Legend

Number	Meaning
1	Calibration
2	Brightness adjustment
3	Contrast adjustment
4	Serial Line setting
5	Return back

Following items can be set via service menu:

- Calibration – calibration of the touchscreen sensitive layer,
- Brightness – brightness intensity change,
- Contrast – change of display contrast,
- Serial interface communication parameters *).

*) Can be set only in case they are not given by user application.

To quit from service menu press button **Return**. The on-wall controller will restart.

10.4. Loader

The state, when the Loader is running can be used in cases when the user application is causing any troubles, for example repetitive restarting, inability to connect to the unit, etc.

Loader activation Loader can be activated by interconnecting service jumper. Particular action is called-out according to moment and length of interconnection, see table below.

Interconnection duration	Action
> 1 s – after turning on	Starts the Loader.
> 3 s and < 10 s – while the application is running	Application resets, and Loader starts.
> 10 s	Application resets, and Loader starts with default settings, see chapter 11.

Jumper location The service jumper, located on PCB, is accessible after the cover is taken off, see figure 37.

Note Unwanted interconnection of pins, located close to each other, when the controller is on – has no effect on it's functionality.

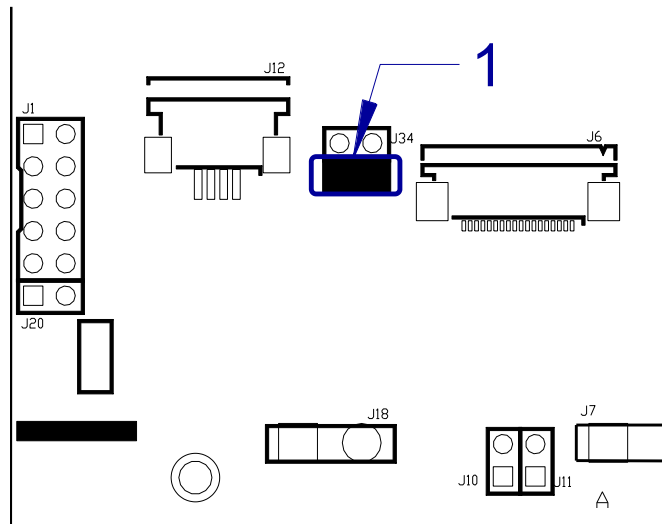

Fig. 38 - Interconnection of service jumper on **AMR-OP71B/xx** PCB

Legend

Number	Meaning
1	Service jumper

11. Factory settings

RS485 configuration Jumpers, which activate the line termination and idle state definition are fitted.

Program settings

Item	Set value
Network type	ARION
Address	1
Speed	38400 bps
Viewing variant	Var. 1
Correction	0.0 °C

Display	Set value
Brightness	100 %
Contrast	50 %
Language	Czech
Display – dimming time	60 s

12. Ordering information and completion

<i>On-wall controller</i>	AMR-OP71B/xx	Complete, see chapter 12.1. Completion
---------------------------	---------------------	----------------------------------------

Note *) **xx** indicates colour design of the product. Available versions are listed in datasheet.

12.1. Completion

<i>AMR-OP71B/xx</i>	Part	Quantity
	On-wall controller	1

13. Maintenance

The device does not require any regular inspection or service, except cleaning and checking backup battery voltage.

Backup battery Backup battery is used for backing-up program, clock and parameters in RAM memory. Its nominal voltage is 3.0 V; nominal capacity is 130 mAh. If battery voltage drops under 1.9 V, then is considered to be discharged. When it happens, it is necessary to change it.

Inspection must be carried out once per year. Expected lifetime of the battery according to producer is 4 years. We recommend to implement the procedure of backup battery measuring direct into application.

Cleaning Depending on equipment usage, the dust is to be removed occasionally from equipment. The equipment can be cleaned by dry soft brush or vacuum cleaner, only when turned-off and disassembled.

Note CR1632 battery can be changed by user after the on-wall controller front panel is dismounted.

14. Waste disposal

Electronics disposal The disposal of electronic equipment is subject to the regulations on handling electrical waste. The equipment must not be disposed of in common public waste. It must be delivered to places specified for that purpose and recycled.